

Capital  
Series

12' to 670

CANBERRA  
TRAMPOLINE

INSTRUCTIONS FOR ASSEMBLY  
MAINTENANCE AND USE



**Important!**

These instructions must be followed for safe assembly and use. Please retain for future reference.



**Important!**

Weight limit 95kg/15 Stone

# TABLE OF CONTENTS

	PAGE
BEFORE YOU BEGIN .....	2
<b>GENERAL INFORMATION</b>	
ASSEMBLY AND SITING .....	3
SPECIAL CONSIDERATION - WIND .....	3
SAFETY .....	3
<b>INTRODUCTION TO TRAMPOLINING</b>	
OVERVIEW OF TRAMPOLINE USE .....	4
BASIC SKILLS - LESSONS .....	5 - 9
<b>DETAILED ASSEMBLY INSTRUCTIONS</b> .....	10 - 14
<b>CARE AND MAINTENANCE</b> .....	15
<b>GUARANTEE</b> .....	16

## IMPORTANT, BEFORE YOU BEGIN, READ THIS MANUAL

Thank you for buying a *tp* Trampoline. This trampoline is designed and manufactured to provide you and your family with many years of fun and exercise but, **for your benefit and safety, please read this manual carefully and in full before assembling and using your trampoline.** Then, please retain this manual for future reference.

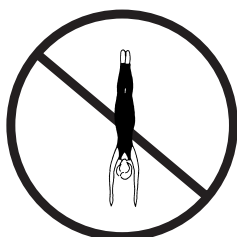

### ! WARNING !

**Do not land on head or neck. Paralysis or death can result even if you land in the middle of The trampoline mat (bed).**

**To reduce the chance of landing on your head or neck, do not do somersaults (flips).**



**Only one person at a time on the trampoline. Multiple jumpers increase the chances of loss of control, collision, and falling off.**

**This can result in broken head, neck, back, or leg.**

### ! REMEMBER !

Trampolines are rebounding devices which propel the user to unaccustomed heights, and into a variety of body movements. Rebounding off of the trampoline, striking the frame or springs, or improperly landing on the trampoline mat (bed) may cause injury.

Misuse and abuse of this trampoline is dangerous and can cause serious injuries.

Inspect the trampoline before each use, and replace any worn, defective or missing parts.

All purchasers and all persons using the trampoline must become **familiar** with the manufacturer's recommendations for the proper assembly, use and care of the trampoline. Each user must also be alert to his or her own limitations in the execution of trampoline skills. **Assembly instructions, selected precautions, recommended instructional techniques and progressions, and suggestions for the care and maintenance of the trampoline are included in this user's manual to promote safe, enjoyable use of this equipment. Please read these in full.**

It is the **responsibility** of the owner or trampoline supervisor to **ensure** that all users of this trampoline are adequately informed of all warnings and safety instructions. **Remember using this trampoline exposes you to the risk of serious injury, including permanent paralysis or even death from landing on the neck or head. The risk exists even if you land on the trampoline mat.**

# INSTRUCTIONS FOR ASSEMBLY, MAINTENANCE AND USE OF *tp* TRAMPOLINES.

## YOUR NEW TRAMPOLINE

### ASSEMBLY INFORMATION

*tp* trampolines must be assembled by an adult. They must be erected exactly in accordance with the assembly instructions, which follow. Enlisting the aid of a helper will make assembly easier. This trampoline does not require any tools to assemble. This pack may contain small parts and is not suitable for children under 36 months until fully assembled. Please take an inventory of all parts before assembly and ensure that all parts listed are included.

Also please take care during assembly as the manufacturing process can sometimes result in the occasional sharp edge and small pieces of waste metalwork. The use of gloves to protect your hands from pinch points during assembly is also recommended. Should there be any missing parts, the toy must not be used until replacement parts have been fitted - the *tp* Customer Services line is 01299 872804.

### SITING

The trampoline must always be used in a well lit area. Under no circumstances should it be positioned on a hard surface such as concrete or asphalt, unless the ground under the trampoline plus the recommended freespace area is covered with a safety surface (please refer to diagram on page 14). Examples of suitable surfaces are grass, sand or a play surface intended for this use. The trampoline must be placed on a level surface. A minimum of 24ft of overhead clearance is required for this product. Adequate horizontal clearance must be maintained from objects and possible hazards including electric power wiring, tree limbs and fencing.

### HIGH WINDS

It is possible for the trampoline to be blown about by high wind. If you anticipate high winds, the trampoline should be moved to a sheltered location, or be disassembled, or the round outside portion (top frame) should be tied to the ground using rope and stakes. At least three tie-downs should be used. Do not simply secure the legs to the ground, as they can pull out of the frame sockets. A special Tie Down kit is available as an accessory.

Three point tie-down using rope and stakes.

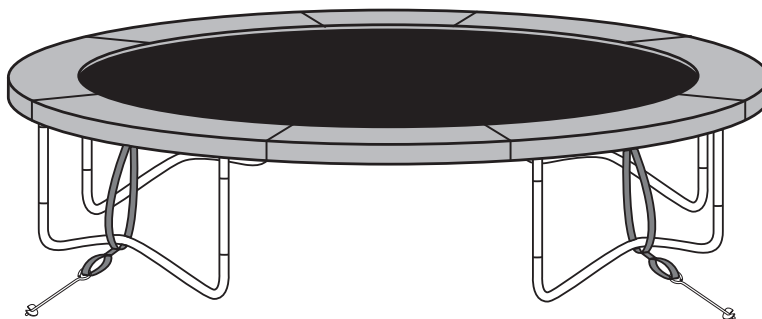

## GENERAL SAFETY GUIDELINES

### USAGE

*tp* trampolines are designed and made for family domestic use only. The Canberra trampoline is intended to be used by one child at a time, weighing less than 95kg/15 Stone. The Canberra trampoline is not intended for use outside of these guidelines. The user should be either barefoot, in socks, or wearing gymnastic shoes. Misuse can result in injury. Inspect the trampoline before use and always replace worn, defective or missing parts. The pads should always be fitted.

### SUPERVISION

Children should always be supervised while they are playing on *tp* trampolines and should be instructed not to use the trampoline in an inappropriate or hazardous manner. We recommend that they do not wear loose-fitting clothing or jewellery than may catch or snag during play. Ensure that younger children do not walk or crawl underneath the trampoline and keep the area around and underneath free from all solid objects at all times.

### WEATHER CONDITIONS

**Special care should be taken as weather conditions change.** In particular, a wet trampoline mat (bed) is too slippery for safe jumping. Gusty or severe winds can cause jumpers to lose control. To reduce the chance of injury, use the trampoline only under appropriate weather conditions. In cold weather, tongues and lips can stick to metalwork at subzero temperatures. In warmer and sunnier weather, parts can become hot, and the temperature should be regularly checked during play, especially metal parts.

### WATER PLAY

Many surfaces can become slippery during water play. Extra caution and supervision is required when combining water (e.g. paddling pools, aqua slides etc.) with other forms of outdoor play.

## USING YOUR TRAMPOLINE - IMPORTANT SAFETY INFORMATION

### BEFORE YOU BEGIN, REMEMBER

1. Trampolines are **rebounding** devices which **propel** the user to **unaccustomed** heights, and into a variety of body movements. Rebounding off the trampoline, striking the frame or springs, or improperly landing on the trampoline may cause injury.
2. All purchasers and all persons using the trampoline must become **familiar** with the manufacturers recommendations for the proper assembly, use and care of the trampoline . Each user must also be alert to his/her own limitations in the execution of trampoline skills. Assembly instructions, selected precautions and suggestions for the care and maintenance of the trampoline are included in this user's manual to promote safe, enjoyable use of this equipment.
3. It is the **responsibility** of the owner to ensure that all users of this trampoline are adequately informed of all warnings and safety instructions.
4. **Never allow more than one (1) person on the trampoline at a time.** Multiple jumpers increases the chance of someone becoming injured. Jumpers may collide with one another, fall off the trampoline, fall on or through the springs, or land incorrectly on the mat.
5. Injury may result from hitting the frame or falling through the springs while jumping or getting on or off the trampoline. Stay in the centre of the trampoline mat when jumping. **BE SURE TO KEEP THE FRAME PAD IN PLACE TO COVER THE FRAME AT ALL TIMES.** The frame pad is not designed nor intended to support the weight of the trampoline user. Do not step or jump directly onto the frame pad.
6. **Always** secure the trampoline against unauthorized and unsupervised use.

### BOUNCING

1. **Always bounce in the centre of the bed.** Bouncing near the edge of the bed can lead to injury and can also stretch the springs. The frame pad is not designed nor intended to support the weight of the trampoline user. Do not step or jump directly onto the frame pad.
2. **Avoid bouncing too high.** Stay low until you can control your bounce and land consistently in the middle of the bed.
3. **Learn basic bounces and body positions thoroughly before trying more advanced skills.** Attempting a manoeuvre beyond present skill levels increases the chance of loss of control. A controlled jump is one where the landing is in the same spot as the take off. Before learning a more difficult manoeuvre, the preceding one should be performed consistently under control.
4. **Do not attempt somersaults without proper instruction and supervision.** Landing on your head or neck, even in the middle of the trampoline mat increases the risk of a broken neck, which can result in paralysis or death.
5. **To regain control and stop your jump, bend your knees sharply when you land.**
6. **Do not bounce for too long or when tired.**
7. **Do not use the trampoline when under the influence of alcohol or drugs.**

## INTRODUCTION TO TRAMPOLINING - BASIC SKILLS

The first periods of trampoline use should focus on learning fundamental body positions and practicing the basic bounces that are described the following pages of this manual.

During this learning period, jumpers should practice these basic techniques and perfect them. Braking, or checking the bounce should be taught first and stressed as a safety measure. Jumpers should brake their jump whenever they start to lose balance or control. This is done by simply bending the knees sharply upon landing and absorbing the upward thrust of the mat (bed). This enables the jumper to stop suddenly and avoid losing control.

In trampoline use, the take-off point and landing point of a good, controlled jump is on the same spot. An exercise is considered learned only when a jumper is able to perform it consistently. Jumpers should never proceed to any advanced step until they can perform all previous techniques consistently. Please see below for information about marking the centre of the bed with a target area.

Allow each jumper a brief turn on the trampoline. Extended bouncing exposes an over tired user to an increased risk of injury. Longer turns tend to lessen the interest of others waiting to jump.

Clothing should consist of T-shirt, shorts and regulation gymnastic shoes, heavy socks, or jumpers may be barefoot. Beginners may wish to wear protective clothing such as a long sleeve shirt and trousers until correct landings are mastered. This will reduce the chance of mat (bed) burns from improper landings on elbows and knees. No hard sole shoes should be worn as they cause excessive wear on the trampoline mat (bed).

The trampoline mat is several feet from the ground. Jumping off the trampoline to the ground or any other surface may result in injury. Jumping onto the trampoline from a roof, deck, or other object also represents a risk of injury. Smaller children may need assistance getting up on or down from the trampoline. Mounting and dismounting properly should be a strict rule from the very beginning. Users should climb onto the trampoline by placing their hands on the frame and stepping or rolling up onto the frame, across the springs, and onto the mat (bed). Do not step directly on the frame pad or grasp the frame pad when mounting or dismounting the trampoline. Users should always place their hands on the frame while mounting or dismounting. To dismount, jumpers should walk to the side of the mat (bed), bend over and place one hand on the frame, then step from the mat to the ground.

Reckless bouncing should not be permitted. All skills should be learned at moderate heights. Control rather than height, should be emphasized. Jumpers should be forbidden to practice alone and unsupervised.

### MARKING A JUMPING TARGET AREA

1. You will need two pieces of string - each about fifteen feet long - and a spray can of white outdoor general purpose paint. Tie the string to the trampoline at the 12 o'clock to the 6 o'clock position. Then tie a piece of string at the 3 o'clock and 9 o'clock position to determine the centre of the bed.
2. Follow the manufacturer's instructions and make sure that the trampoline bed surface is dry and free of dust. Mark the centre of the trampoline bed by spraying a small white dot where the strings cross. Let the paint dry.
3. The best target is a small "X" at the centre of the trampoline. There are two simple methods of creating a template for marking the target area.
  - a. Using masking tape, create an "X" on the trampoline surface, or
  - b. cut out an "X" in a 22" by 22" piece of medium weight paper, (as shown alongside).
4. Using the white paint, spray over the template "X". This will create a white "X" at the centre of the trampoline.

This is now the trampoline "target" for jumping.

Masking tape "X"

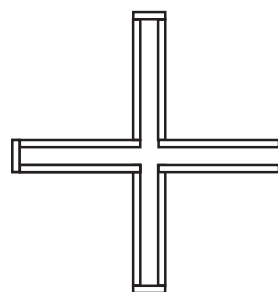

Fold

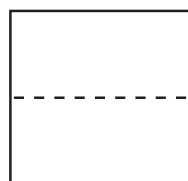

Fold again

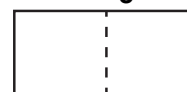

Cut out L Shape and then open

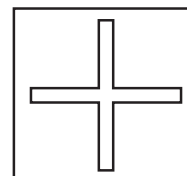

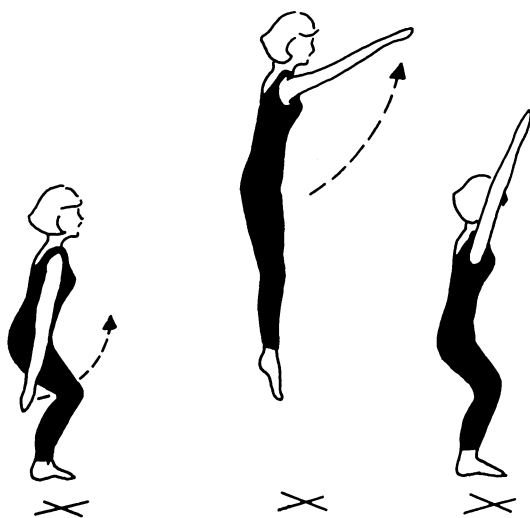

**STANDING BOUNCE**

Use the basic "feet to feet" standing bounce to warm up and get the feel of the trampoline.  
 Try to keep the body straight. Your legs should be slightly apart when landing on the bed and together in the air with toes pointed. As you jump up from the trampoline bed push down hard on the balls of feet and toes, stretch your body upwards and swing your arms forward and upwards.  
 As you come down onto the bed bring your arms down to your sides, part your legs slightly, land with feet flat and flex your knees.

**IMPORTANT: TO STOP YOUR BOUNCE**

Bend your knees as your feet touch the bed. Practice this move so that you are confident that you can stop dead if you find you are getting out of control or going away from the centre of the bed.

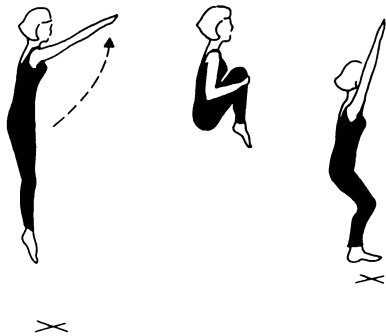

**TUCK JUMP**

Start as if doing just a standing bounce. At the top of your bounce bring your knees to your chest and briefly clasp your shins. let go and return to standing bounce with body straight and arms at sides before landing on the bed.

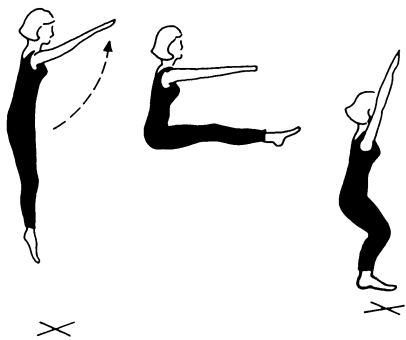

**PIKE JUMP**

Start as if doing a standing bounce. At the top of your bounce, bending your body at the hips, raise your legs, keeping them straight and together, to the horizontal position and briefly touch your shins. Return to the standing bounce before landing on the bed with arms at your sides.

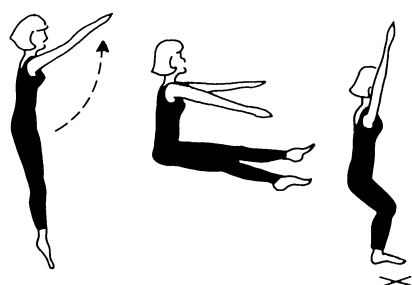

**STRADDLE JUMP**

Similar to the pike jump, but stretch your legs apart as far as possible with the toes pointed and try to touch the top of your feet in the position at the top of the bounce, before returning to land on your feet with your arms at your sides.

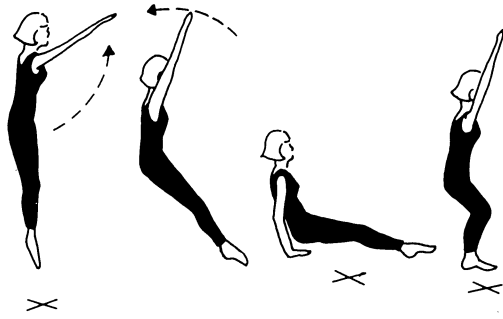

### SEAT DROP

First, without bouncing, just sit in the middle of the bed in the correct landing position. This is with your legs together and straight out in front of you. Lean slightly backwards with back straight, arms beside and slightly behind you with fingers together and POINTING FORWARD.

Next stand up and drop to the Seat Drop position, without bouncing. Then try the move from a little bounce. To bounce back onto your feet lift hips forward and push up with your hands.

Make sure that you drop to the Seat Drop position in the middle of the bed and land back on your feet in the middle of the bed.

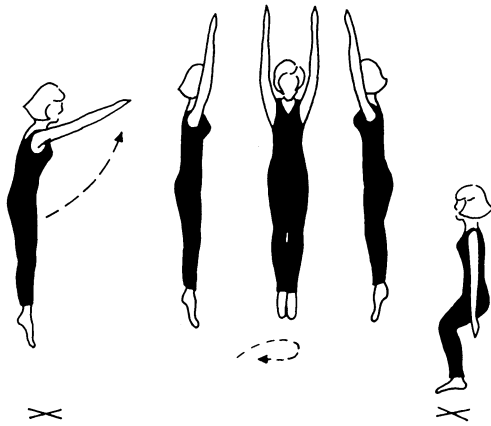

### HALF TWIST

From a Standing Bounce, as you leave the bed raise both arms and bring them together above your head whilst looking in the direction you wish to twist. This action will help you twist your body round so that you land facing the opposite direction, having rotated through 180 degrees. The higher and quicker you lift your arms the further you will twist. Always twist in the same direction.

### FULL TWIST

Performed as for the half twist but with more effort so that you rotate through a full 360 degrees and land in the same position that you took off from. Do not attempt a full twist until you have perfected the half twist.

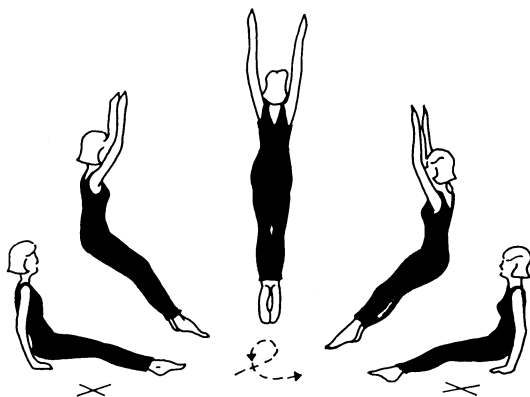

### SWIVEL HIPS

Swivel Hips is really three simple moves put together to make one: seat drop - half twist - seat drop. To start off, try joining the last two parts of the move together so that you land in a seat drop facing the opposite direction.

Once you have got the last two parts of the move together add on the first seat drop, reach upwards and forwards from the first seat drop and turn your hips and body. Your straight legs can then follow through under your body into the second seat drop facing the opposite direction.

### HANDS AND KNEES

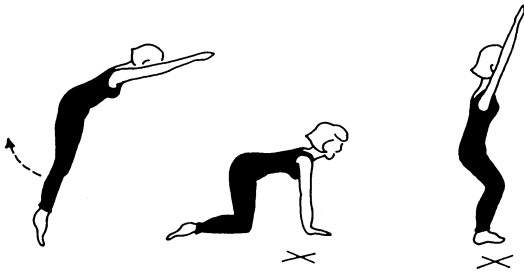

Without bouncing, adopt the hands and knees position as shown. Return to the standing position and with a small bounce lift your hips back and upwards and drop to the hands and knees position. Hands and knees must hit the bed at exactly the same time. Push up slightly with your arms to return to the Standing position.

### FRONT DROPS

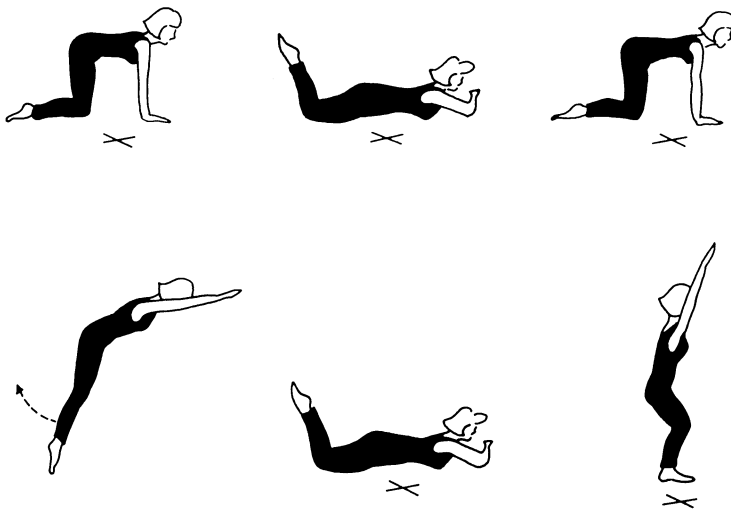

Without bouncing, adopt the Front Drop position by lying flat on your front in the middle of the bed with your head up, arms bent, palms downwards on the bed, with fingers nearly touching each other just forward of your chin. Now adopt the hands and knees position and from a small bounce, kick your legs backwards, and adopt the Front Drop position with your head and arms. Practice bouncing from hands and knees to Front Drop and back again. To do a front drop from standing position it is important to realise that you must DROP to the centre of the bed. You must NOT dive forwards as this can be extremely uncomfortable. Do your first Front Drop from standing without bouncing by lifting your hips and heels upwards and backwards. It is better to move backwards when doing a Front Drop than to dive forwards. When landing in the Front Drop position, your forearms, stomach and thighs should all hit the bed at the same time. Push with your arms to return to the standing position in the centre of the bed.

### BACK BOUNCING

As an introduction to the Back Drop and to get the feel of where and how to bounce on your back, try back bouncing. Without bouncing, adopt the Back Drop position. Keep your chin forward and head off the bed by continuing to look forwards. With legs and hands up in the air start regular bouncing motions by bringing your knees up towards your chest to push your body into the bed, then open your legs out to lift off the bed. Tuck them in as you hit the bed and open out to leave the bed. Work with the bounce and you'll find this an easy and enjoyable move.

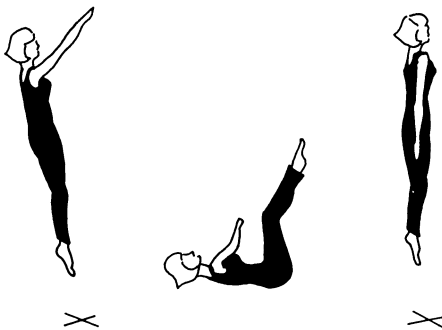

### BACK DROP

First without bouncing, adopt the Back Drop position. Keep your chin forward and head off the bed. Legs should point upwards and forwards, at about 60 degrees from the surface of the bed and arms at a similar angle. From standing position with hardly any bounce, keeping sight of the outside of the trampoline *all the time*, kick both legs up and forward lifting hips and aim to land in the centre of the bed on the upper part of your back. Lift your hips up and forward and bear down with your legs to return to standing position.

## ROUTINES

Once you have mastered all these moves you can start performing them one after the other to create a routine. Start your routine with a few standing bounces to set your rhythm.

Try to perform each skill neatly, at a consistent height and always in the middle of the bed.

You can put together moves in whatever order you wish. Some are more difficult than others. Here are two suggested basic routines.

Start with Routine A. Once you have mastered Routine A you are ready to start Routine B.

### Routine A

1. Front Drop
2. To Feet
3. Tuck Jump
4. Half Twist
5. Straddle Jump
6. Seat Drop
7. To Feet
8. Pike Jump
9. Full Twist
10. Standing Bounce

### Routine B

1. Seat Drop.....)Swivel
2. Half Twist to Seat Drop ....)Hips
3. Half Twist to feet
4. Half Twist
5. Tuck Jump
6. Front Drop
7. To Feet
8. Straddle Jump
9. Back Drop
10. To Feet

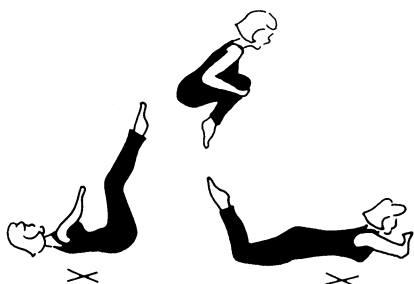

There are a number of other moves that fit together well. These are usually called progressions.

When you are ready try some of these:

1. Seat Drop to hands and knees to Front Drop.
2. Seat Drop to Front Drop.
3. Front Drop to Seat Drop.
4. Back Drop to Front Drop.

## BEWARE OF....

You may have noticed that the Knee Drop is missing from the list of moves. This is a very simple move which is no longer recommended by the British Trampoline Federation, as it can cause the bouncer to lose control, bounce forward and fly head first off the side of the trampoline. It has also been known to cause back injuries.

Remember that if you happen to do a Knee Drop you are, in fact, isolating two of your bodies vital control and energy absorption joints; your knees and your ankles.

There are many more trampoline moves that require a higher degree of skill and training and should be taught by a qualified trampoline coach.

It is not always realised that somersaults and moves involving full rotation in the air are potentially very dangerous if attempted without proper training and supervision. For this reason we recommend that somersaults are not attempted unless under the supervision of a properly qualified trampoline coach.

## TRAMPOLINING AS A SPORT ...

If you would like to take up trampolining as a sport, contact your nearest Leisure Centre and ask about trampoline lessons. If they are unable to help you, contact the British Trampoline Federation at:

Ford Hall  
Lilleshall National Sports Centre  
Newport, Shropshire  
TF10 9NB

Telephone: 01952 820 330

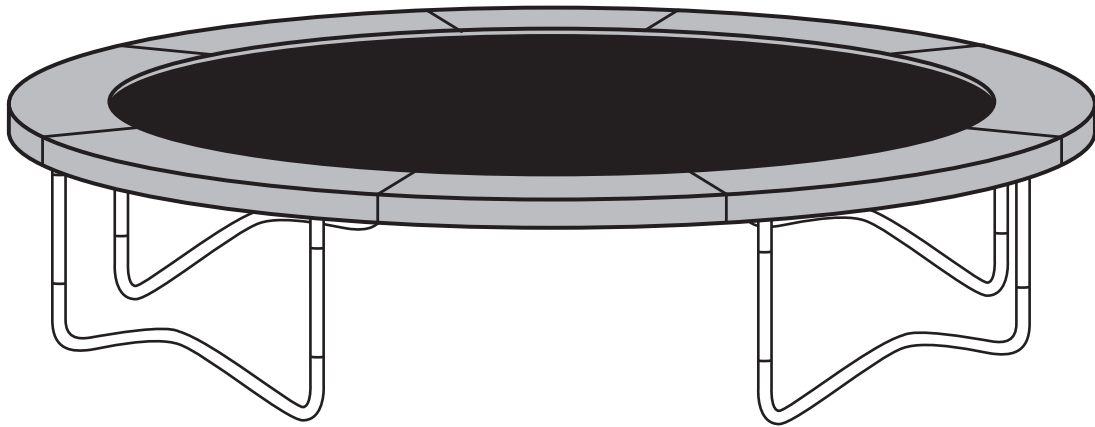

Contents - Please check

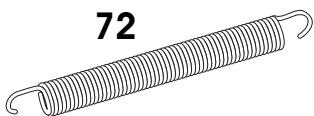
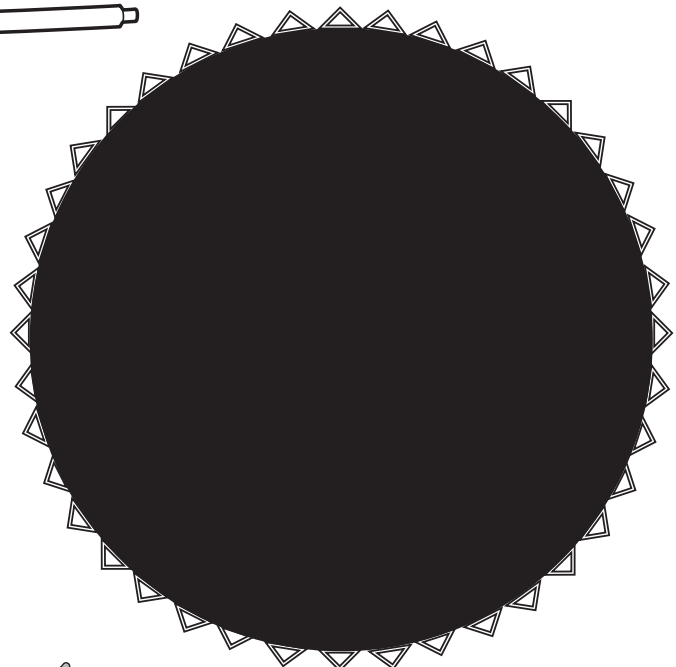
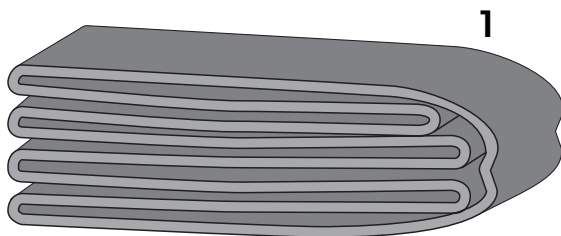
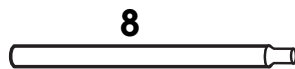
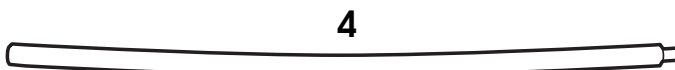
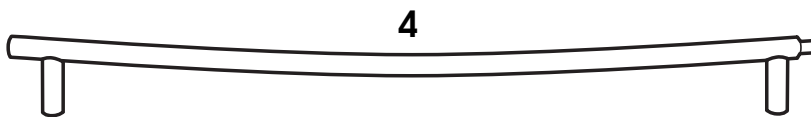
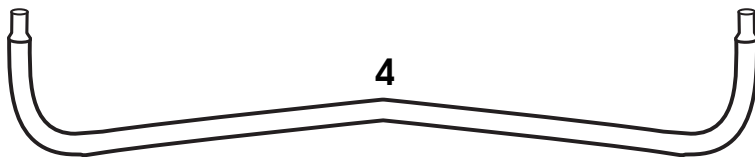

**2**

**Assembly**

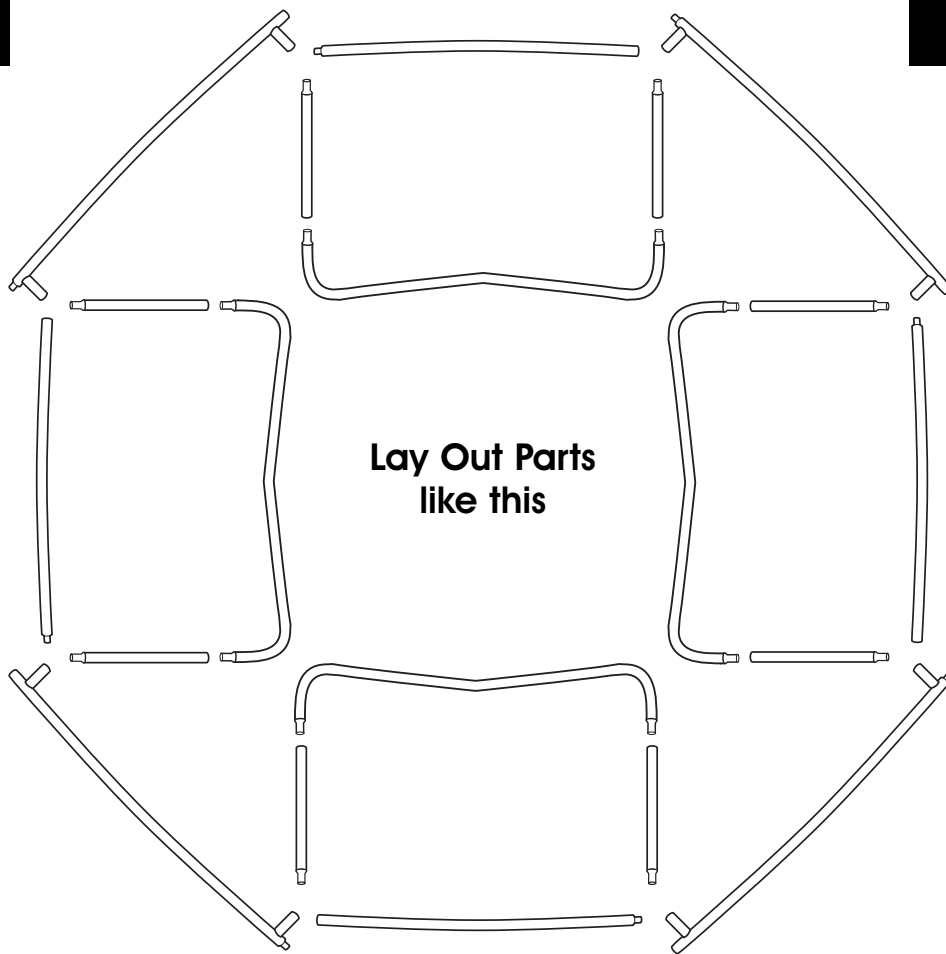

Lay Out Parts  
like this

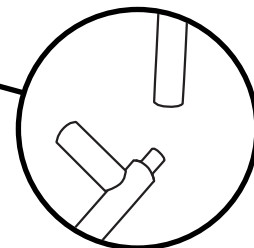
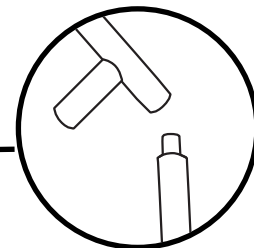

**3**

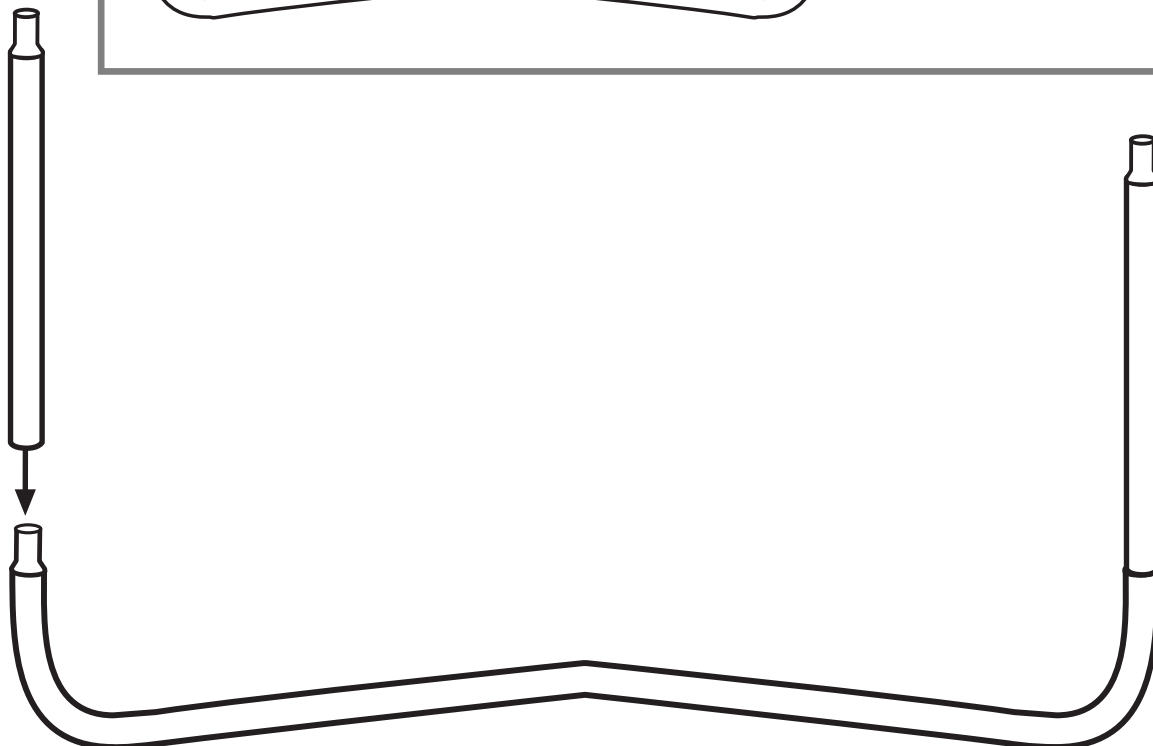
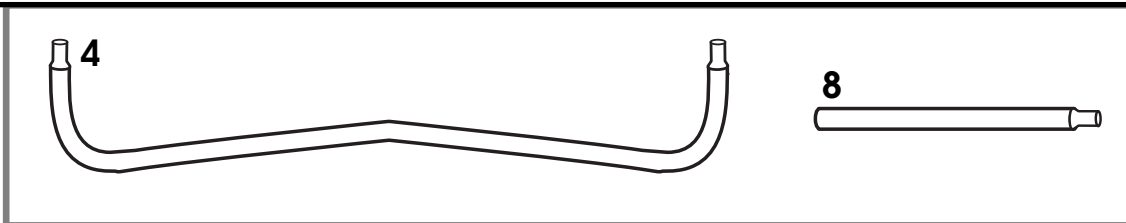

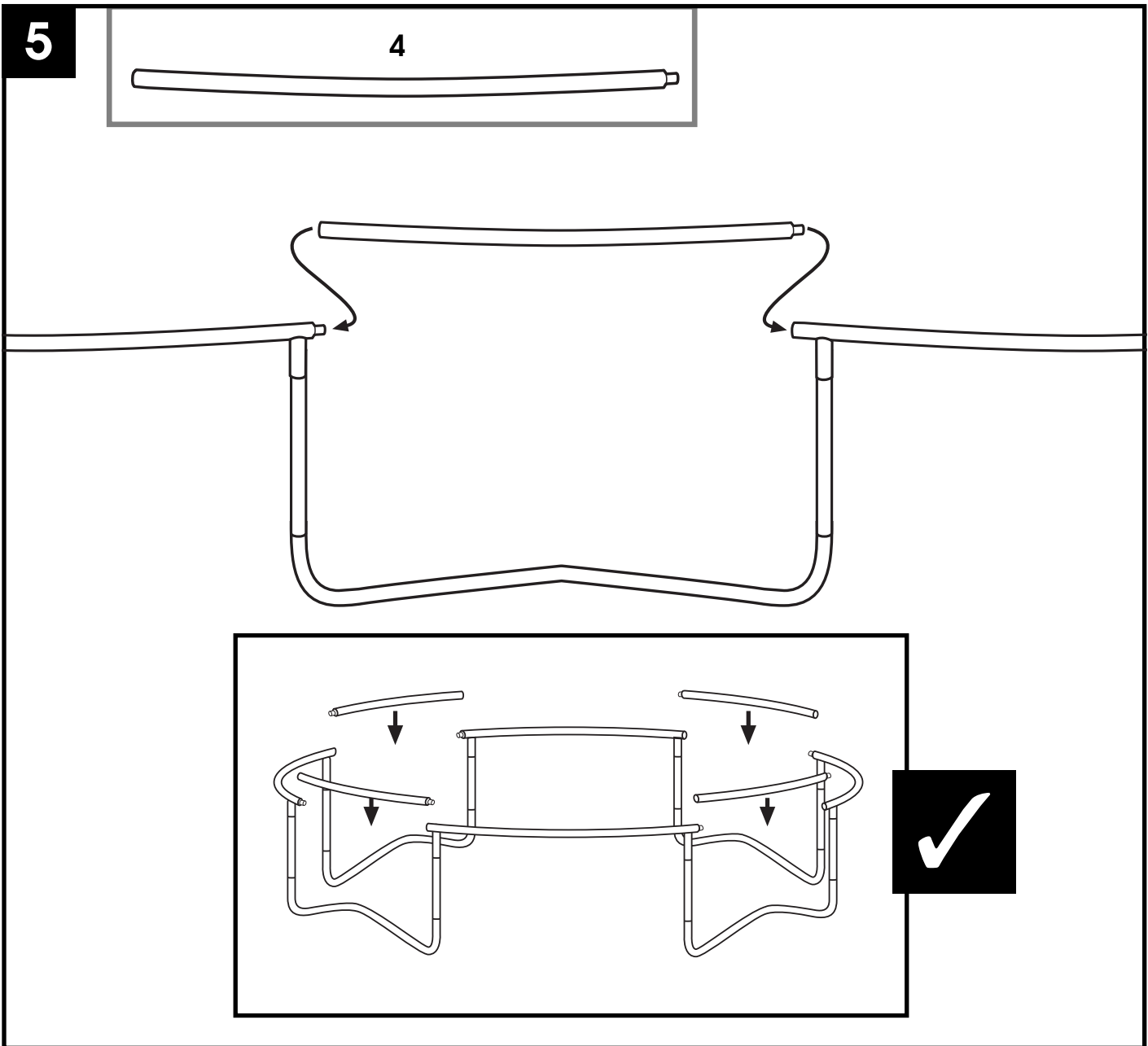
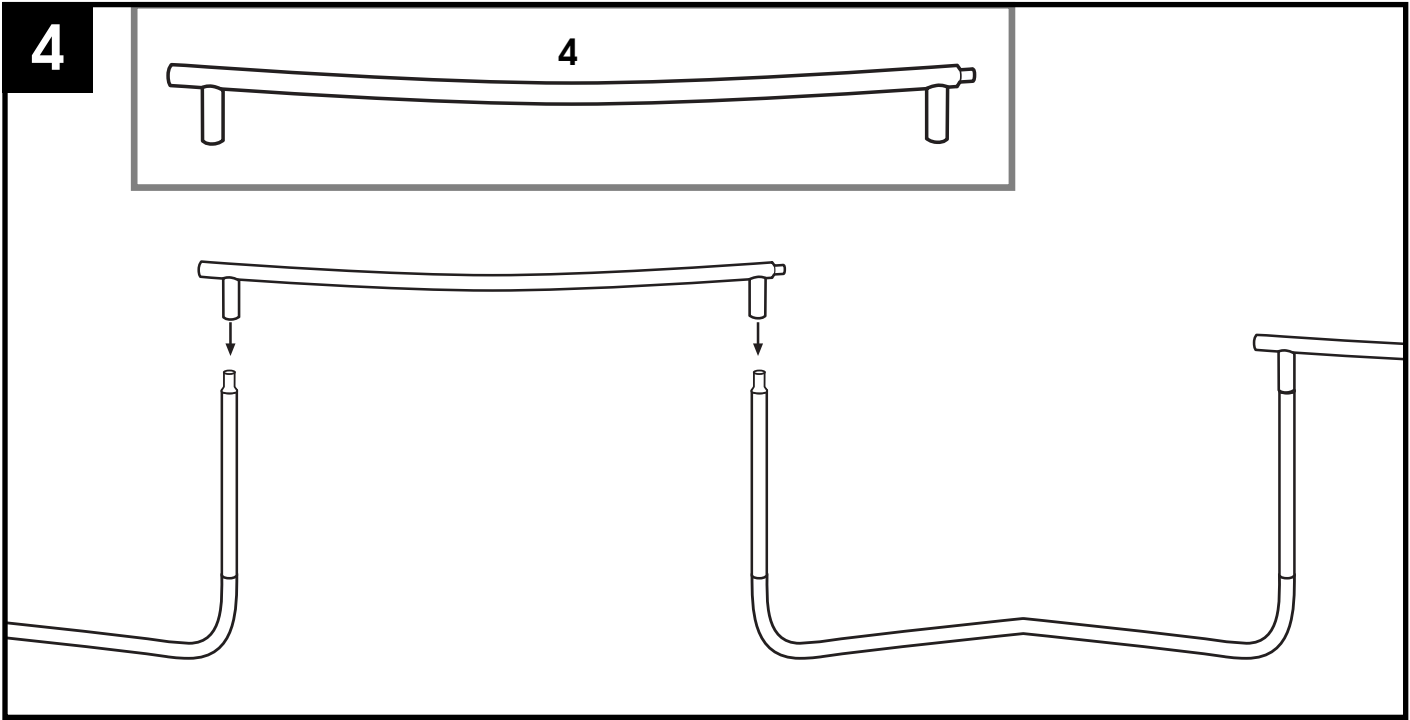

6

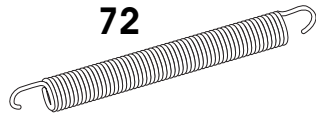
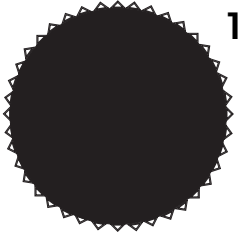

### Mat/Spring Attachment

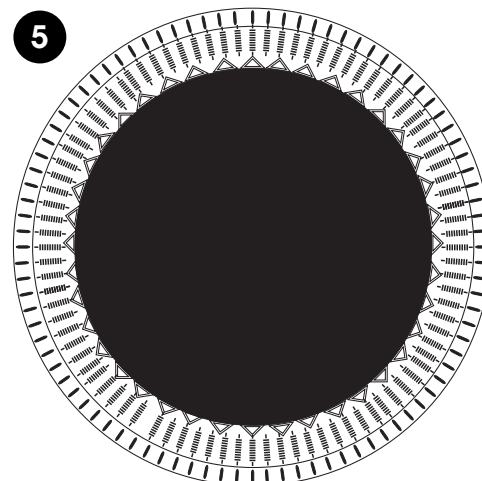
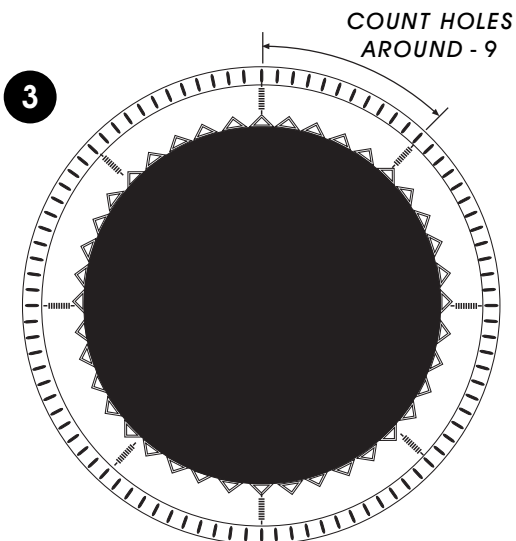
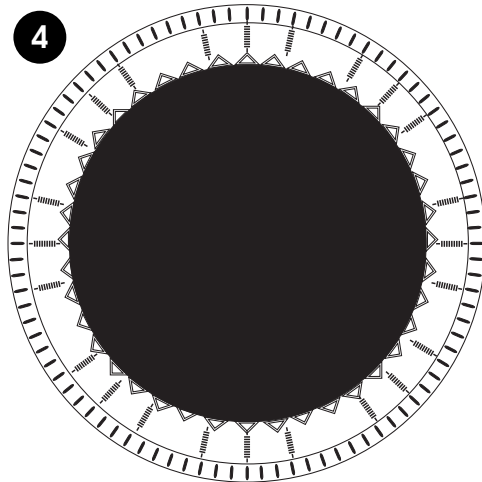
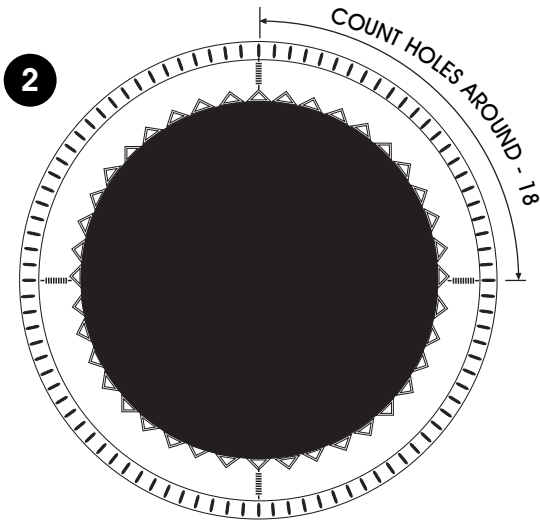
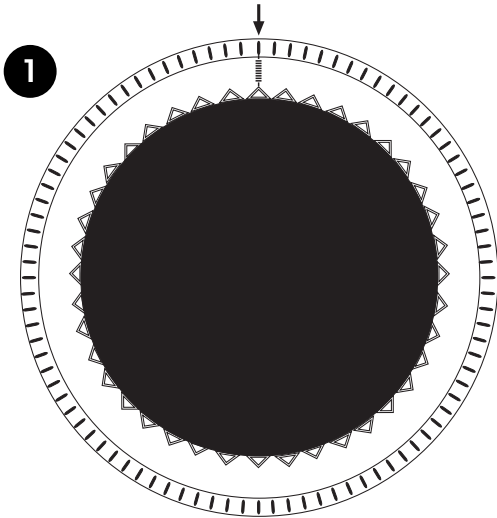
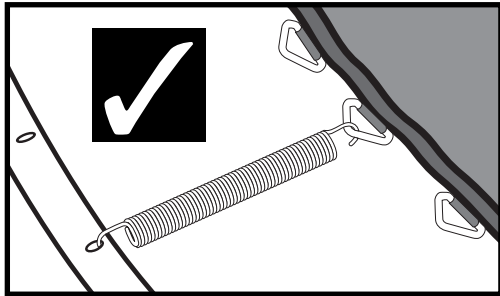
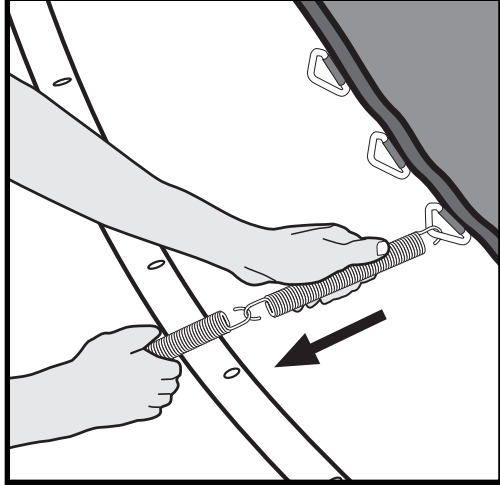

7

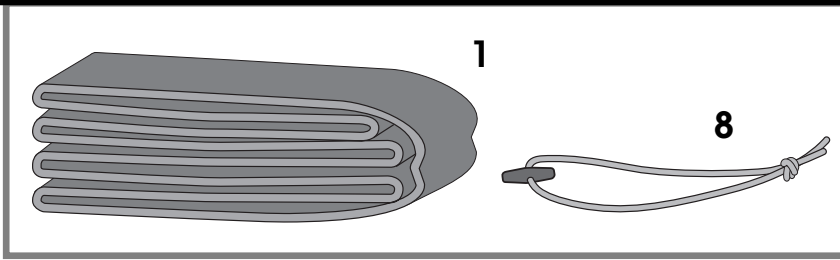

### Pads Attachment

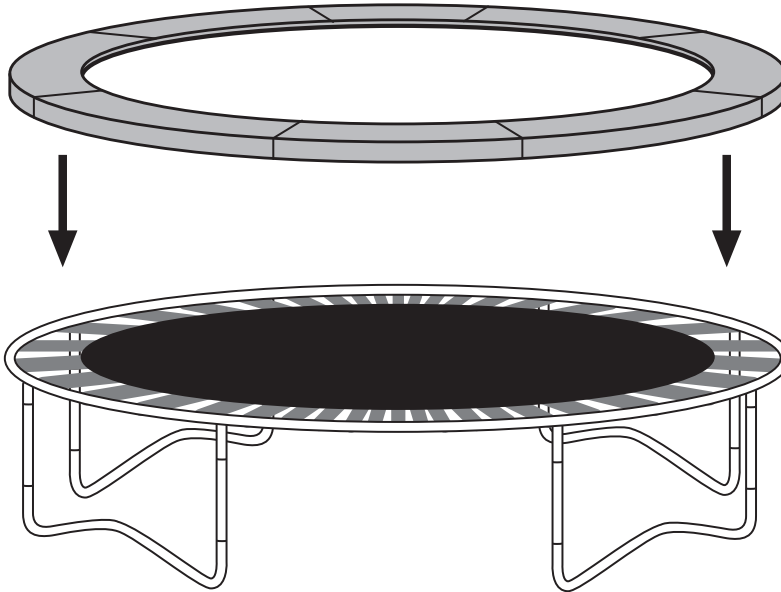
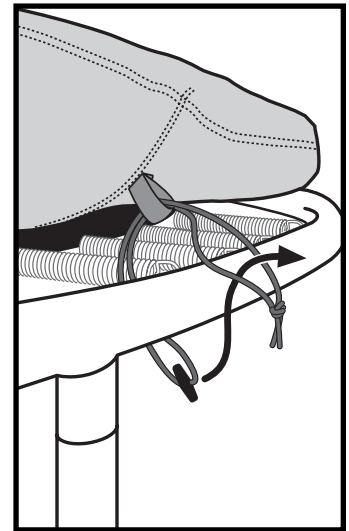
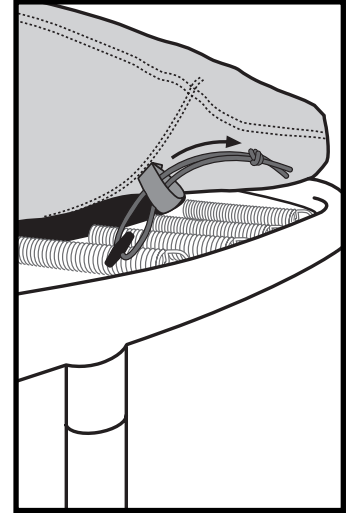

### Freespace/Safe Play Diagram

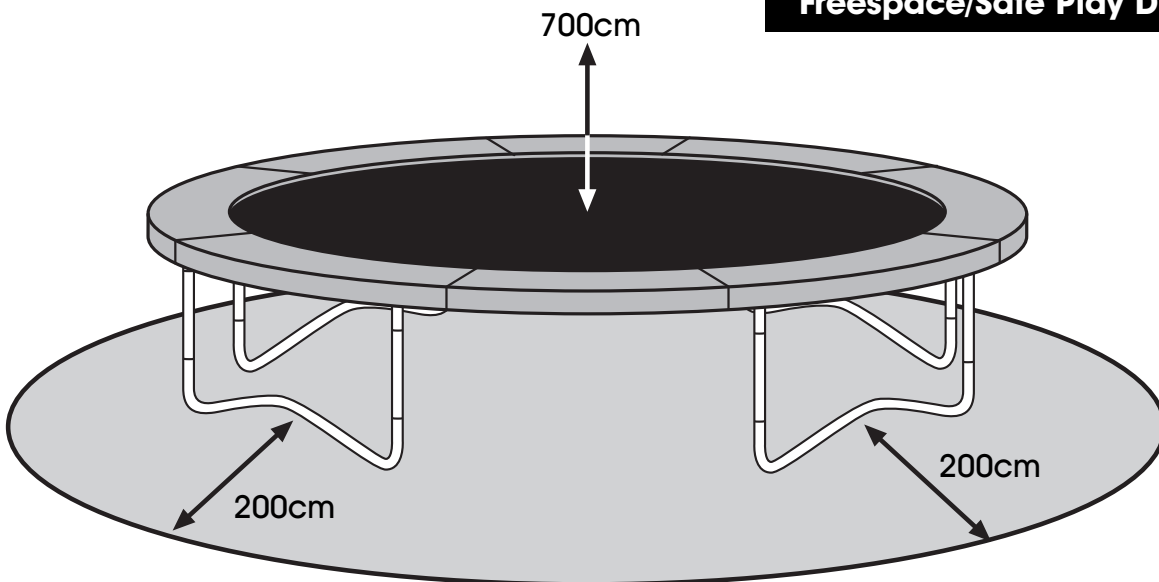

#### Recommended Free Space:

The Safe Play Area refers to the zone extending 200cm (2 metres) beyond the toy on all sides and 700cm (7 metres) above the toy. The Safe Play Area must be free from all structures, landscaping, trees and branches, rocks, wires, sprinkler heads and other similar obstacles to safe play. Children can be seriously injured running or colliding into such obstacles.

# CARE AND MAINTENANCE OF YOUR TRAMPOLINE

## GENERAL

Your trampoline is designed to stand outside all year round and generally requires very little maintenance. However, a little care and forethought can add years to your trampoline's life. Remember that the bed (mat) and frame pads are made of synthetic materials and are easily damaged by cigarette ends, fireworks and bonfire debris.

## FRAME

Do not sit or stand on the frame or the frame pads while the trampoline is in use as this restricts the frames natural reflex action. Oil or petroleum jelly applied where the springs hook into the frame will reduce squeaking and frame hole wear. If surface rust appears it should be removed with either a wire brush or coarse sandpaper, and the area treated with a non-toxic paint.

## FRAME PADS

Frame pads are there to protect the user from any fall or landing on the springs and frame. On no account should people be permitted to sit or stand on them when the trampoline is in use. You should also make sure that smaller users do not use the inside edges of the pads as a "handle" when getting up on to the trampoline.

## THE MAT

The mat (bed) will, over the years, be gradually weakened by the effects of ultra violet radiation. Therefore, the more it can be protected from direct sunlight the longer it will last. A little mould or mildew should not harm the mat. Do make sure that shoes are removed before bouncing and ensure that any other sharp objects such as belt buckles, brooches and jewellery are removed too.

## THE SPRINGS

Do not stand on the springs whilst the trampoline is in use. Try not to bounce on to the springs. They are not designed for this sort of stress and can become stretched, misshapen and weakened. If you find you have any stretched springs, it is important to replace them as soon as possible to avoid damage to the trampoline mat and avoid overloading and therefore damaging the remaining good springs

## FIRE RISKS AND DISPOSAL

Never allow toys to be placed or used near a fire. When it becomes necessary to dispose of your equipment, remove all bolts and disassemble. Store out of the reach of children until it can be properly disposed of.

## METHODS OF ACCIDENT PREVENTION

### JUMPER'S ROLE IN PREVENTING ACCIDENTS

Education on the part of the user is a must for safety. Users must first learn a low controlled bounce and the basic landing positions and combinations before proceeding to intermediate skills. Jumpers must understand why they have to master "control" before they can start thinking about other moves. Understanding the proper progression of skills in jumping on a trampoline must be the first lesson.

### SUPERVISORS ROLE IN PREVENTING ACCIDENTS

It is the responsibility of the supervisors of trampoline users to provide knowledgeable and mature supervision. They need to know and enforce all the rules and warnings set forth in this manual in order to minimize the likelihood of accidents and injuries and to inform users of these rules. During periods of time when supervision is unavailable or inadequate, this may require that the trampoline be disassembled, placed in a secure area, or otherwise secured against unauthorized use. It is the responsibility of the supervisor to be sure that the users are fully aware of the safety guidelines which are printed on the pads.

**These instructions are issued in the interest of child safety, and we do ask you to follow our advice.**



## Trampoline Guarantee

**Thank you** for purchasing one of our quality trampolines. This product carries a **5 Year Guarantee** against rust causing failure on the galvanised steel frame.

**tp** Activity Toys guarantees to you the original retail purchaser that for 5 years rust will not cause the trampoline frame to fail structurally. (Failure is defined as rusting from the inside through to the outside ie. perforation).

In the unlikely event of such rusting occurring **tp** will either supply replacement parts of the affected area, or replace the toy if the parts are no longer available.

Galvanised products are very tough but they may require maintenance from time to time (as detailed in the Maintenance Notes at the front of this handbook). Regular inspections are important. Any surface rust, staining etc. should be treated in accordance with these instructions and are not covered by the **5 Year Guarantee**.

This Guarantee does not apply to any part if damage has been caused by abuse, vandalism, misuse, accident or non-maintenance or if the original purchaser resides outside the British Isles or Ireland. All other component parts are guaranteed for twelve months.

To be covered by this **Guarantee** it is essential that you complete and return one **Guarantee Registration**, listing all products purchased. As an additional bonus you will then automatically be entered into the **Quarterly Prize Draw**.

This helps us to monitor and maintain our performance as market leaders in the design and manufacture of outdoor play and associated products. It also helps us to communicate quickly with you should the need arise and to keep you up to date with the developments in our range.

### Claim Procedure

Should a claim be necessary please write to our Customer Services Department, **tp** Activity Toys Ltd., Stourport-on-Severn, Worcestershire, DY13 9EX, England.

We would require the following information and we recommend that you complete some of these details now:

**Your name, address and daytime/evening telephone number.**

**Product Name.**

**Guarantee Number.**

**Date of Purchase.**

**Where Purchased.**

**Original Till Receipt.**

**Identification of the Affected Part(s) - Photographs preferable.**

Please do not send products or parts at this stage as this may not be necessary.

The product guarantee number is:



Made in China: **tp** Activity Toys Ltd., Stourport-on-Severn, Worcestershire, England. DY13 9EX

Email: [customerservices@tp toys.com](mailto:customerservices@tp toys.com)  
Website: [www.tptoys.com](http://www.tptoys.com)

Customer Service:  
Spare Parts +44 (0) 1299 872803  
Technical Helpline +44 (0) 1299 872804